

„In-Barrel Power Supply“



59th Annual Fuze Conference
May 5th, 2016
Harald Wich
Diehl & Eagle Picher GmbH

Gut vernetzt: Fischer
und Dichter Geno
Leech bei der Arbeit



DIEHL & EAGLE PICHER
Batterie-Systeme

**„If you can't tell it in 15 minutes;
Don't tell it at all“**

Geno Leech, Fisher Poet,
Chinook WA, USA

... let's get started

Copyright Diehl & Eagle Picher GmbH

Overview

- ◆ History, the large Calibre Fuzes
- ◆ Electrolyte Distribution
- ◆ High Acceleration and Spin
- ◆ Miniaturised Fuze Battery
- ◆ Load Management
- ◆ Conclusions

Legacy Fuze Batteries

- ◆ PS115 (lead)
- ◆ MOFA post launch
- ◆ DEP 1400x series

- ◆ Rise-time requirements

- **50 milliseconds or more** to minimum voltage
- for launch velocities between 300 – 1000 m/s
 - trajectory delta < 50 – 200 m

- likely suitable for time- prox- point-detonating- fuze

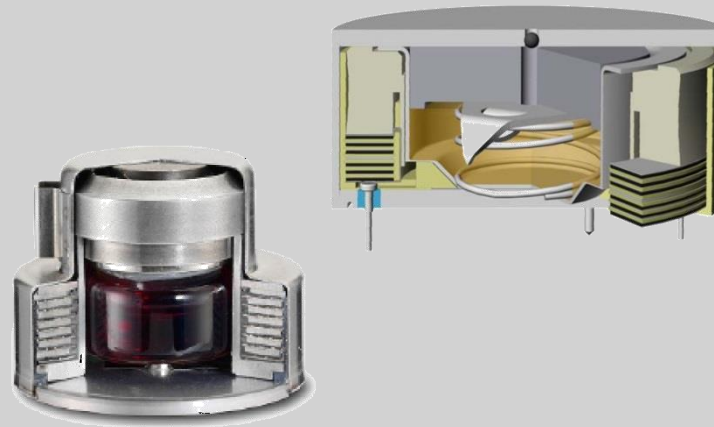

Legacy Battery Rise-Time OK for legacy Fuzes!

New (challenging) Requirements

- ◆ Smaller calibre
 - direct fires
 - short muzzle safety distance
 - early functions – in-/shortly after barrel exit
 - more precise timing
- ◆ Typical Requirements
 - DoD 2014.1 SBIR **10 ms** (low current), 100 ms (max current)
 - various DEP customers **single digit ms**

Factor of ten or more Rise-Time Reduction!

Electrolyte Distribution

Spin

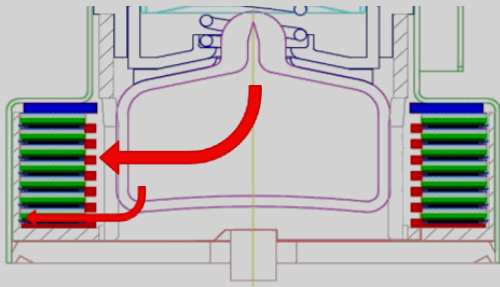

„low charge“ acceleration and spin

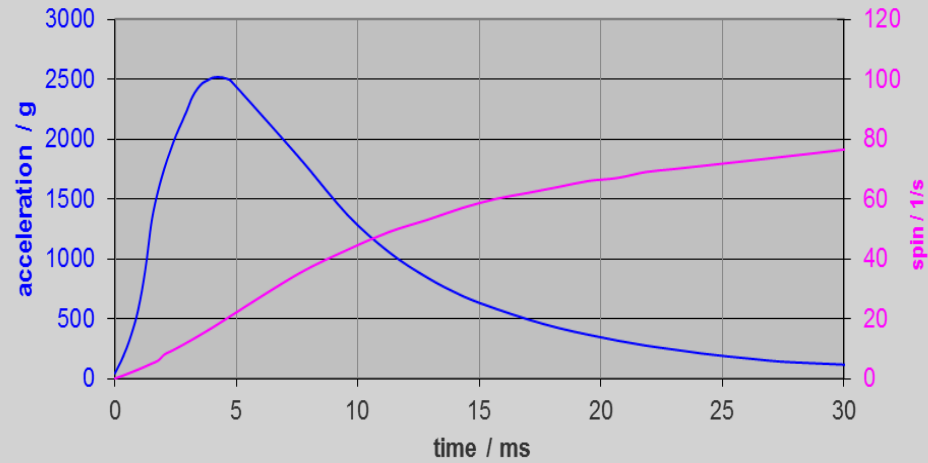

Acceleration

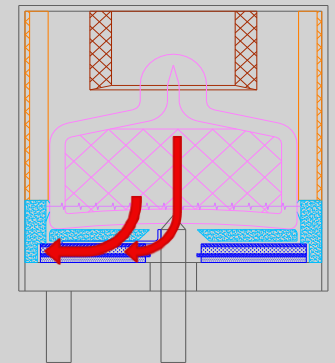

barrel

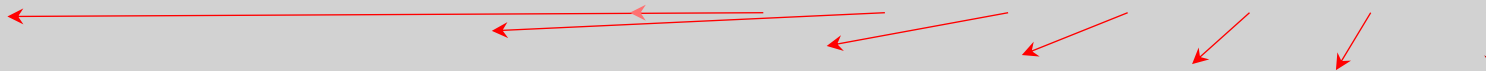

force vector

No Pain, no Gain

The 155 mm Artillery Dilemma

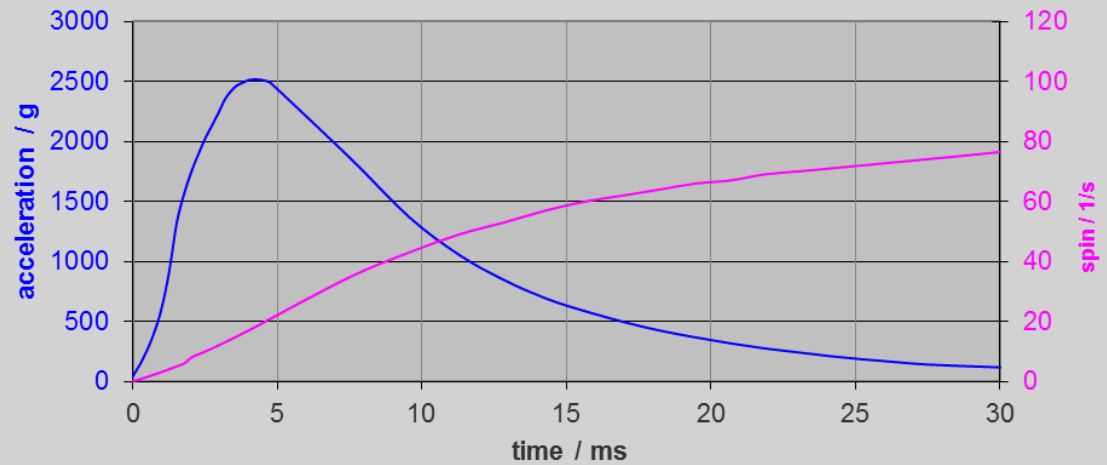
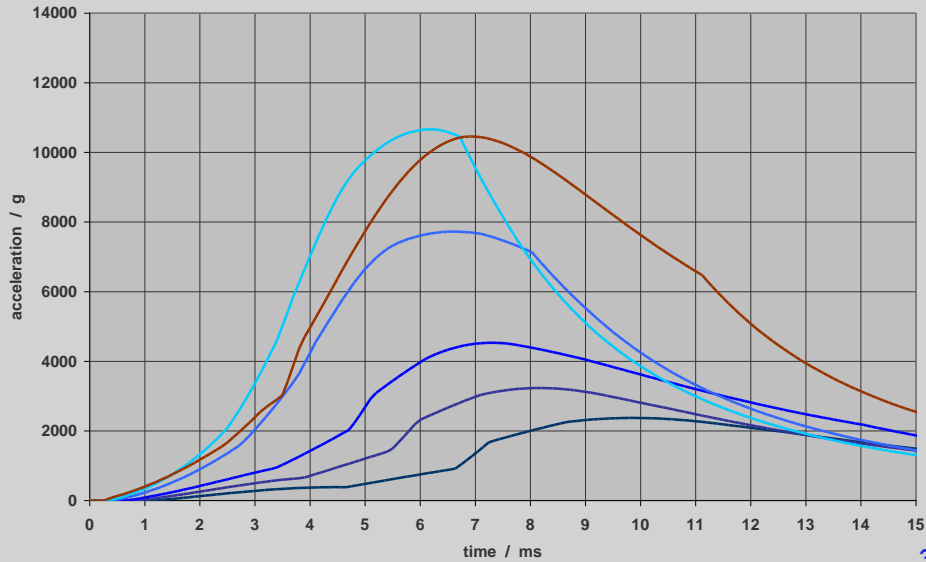

Acceleration and Spin can be rather low

Activation in 40 mm Infantry Grenade

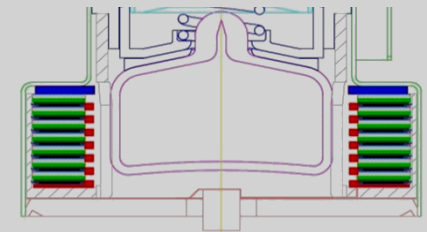
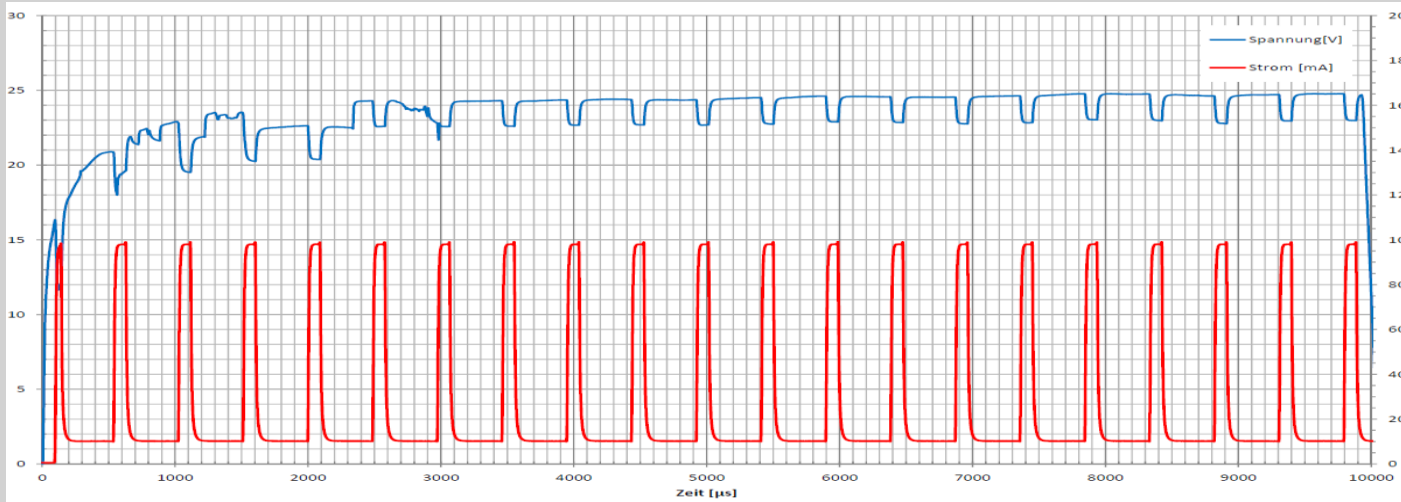
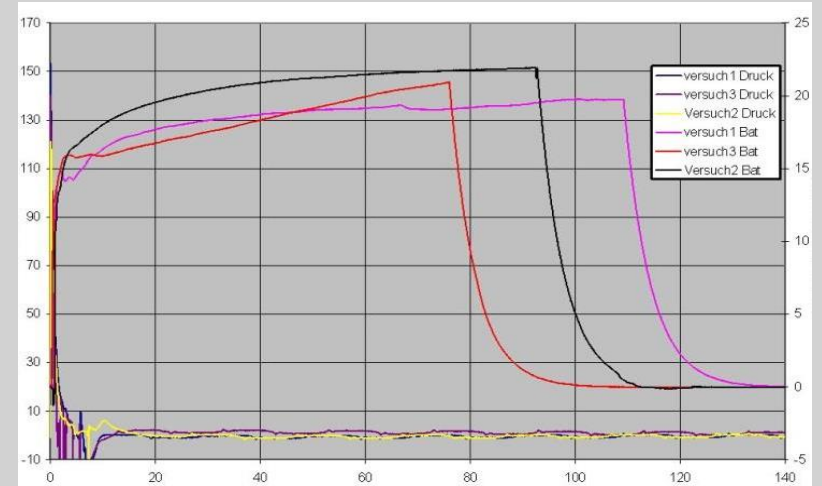
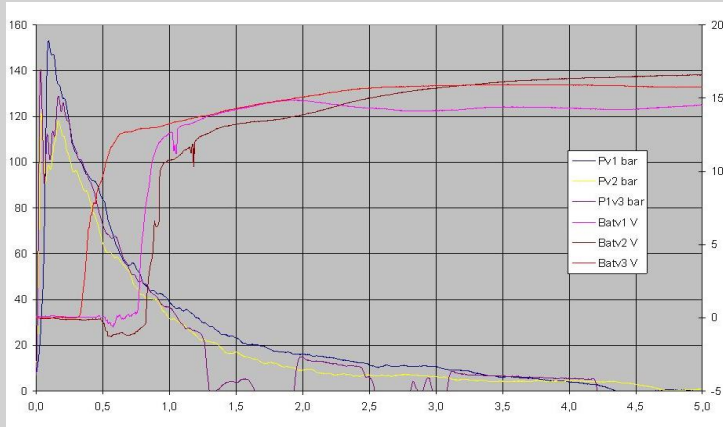

DEP 1400x at RT

Miniature Fuze Battery Activation

◆ High Acceleration (no/low spin)

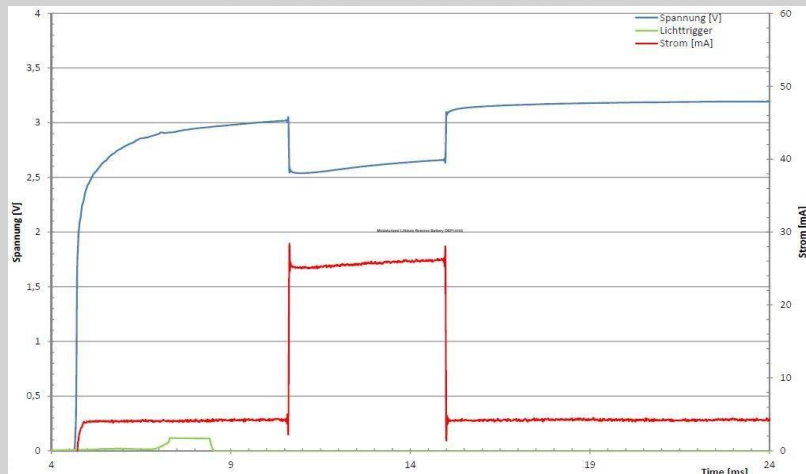

DEP 14103
at -46°C

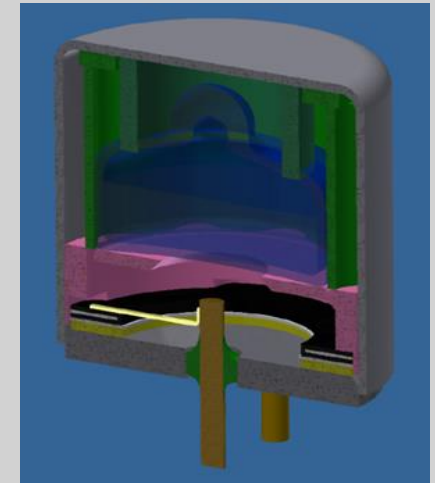

DEP14103.01 RT <--> RT + spin

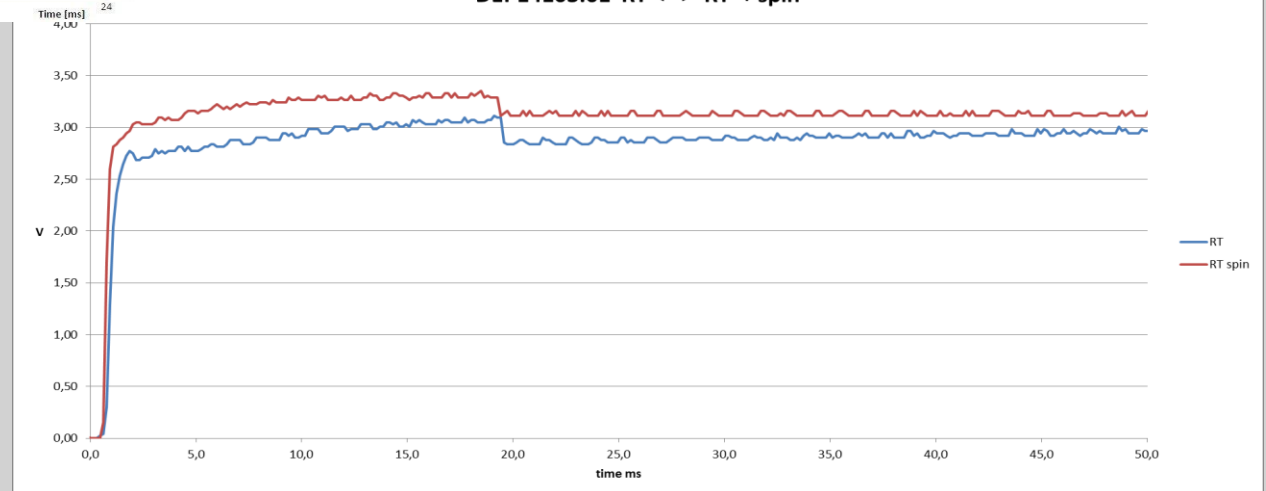

Miniature Battery Rise Time

- ◆ Low Acceleration (2500 g's continuous, no spin)

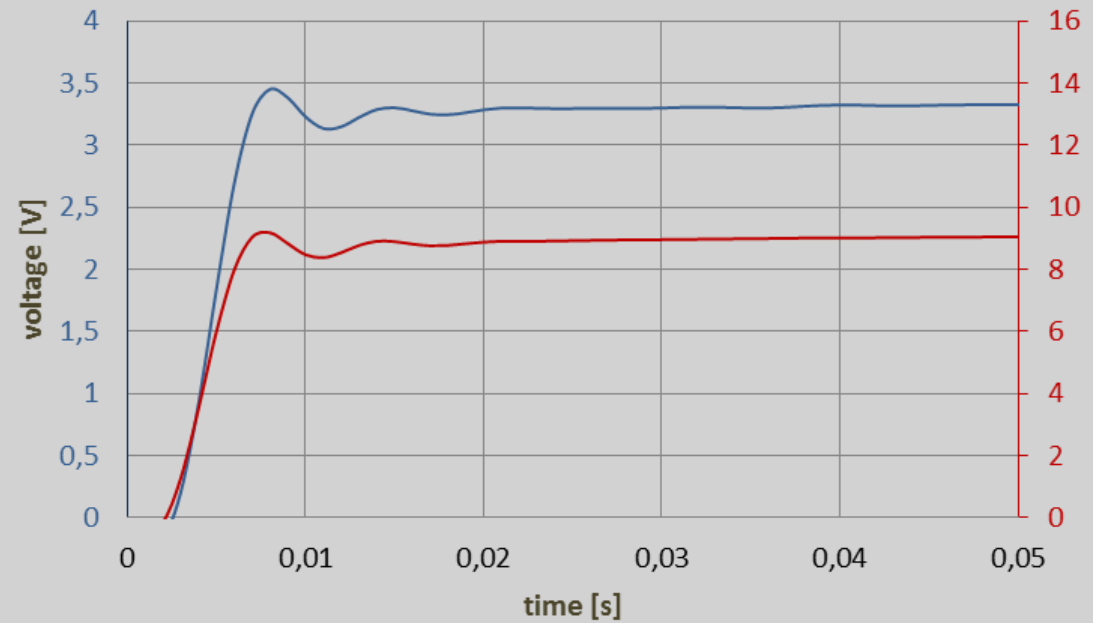
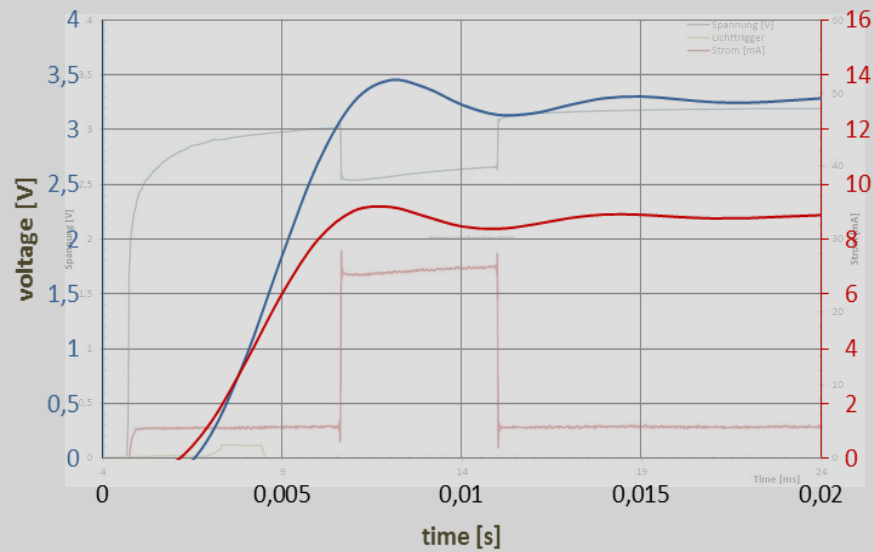

Load Dependence of Rise Time

DEP14020.03; 2s; -46C, U= 9000 1/min; Dez.15

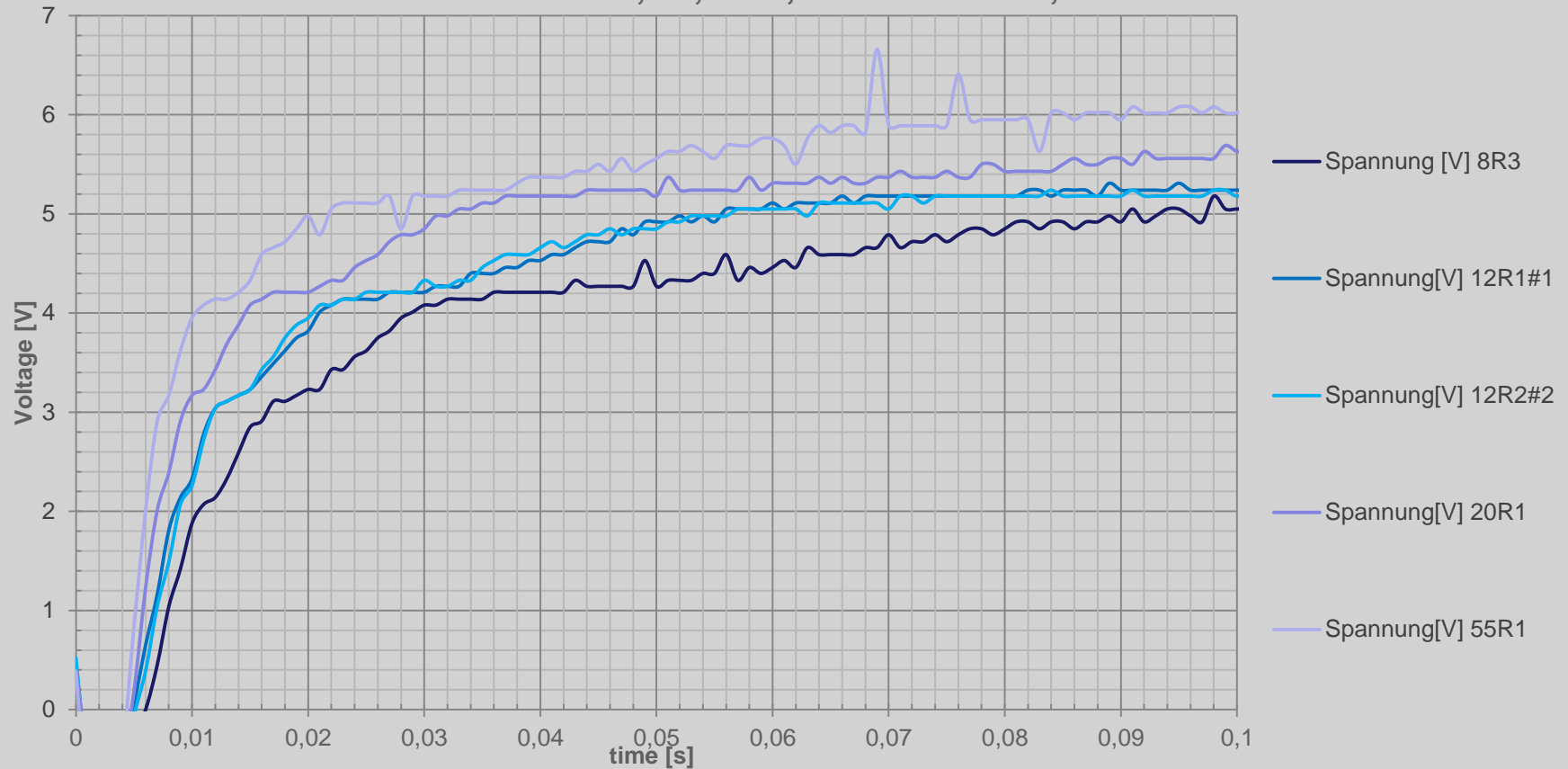

Load Dependence of Rise Time

DEP14020.03; 2s; -46C, U= 9000 1/min; Dez.15

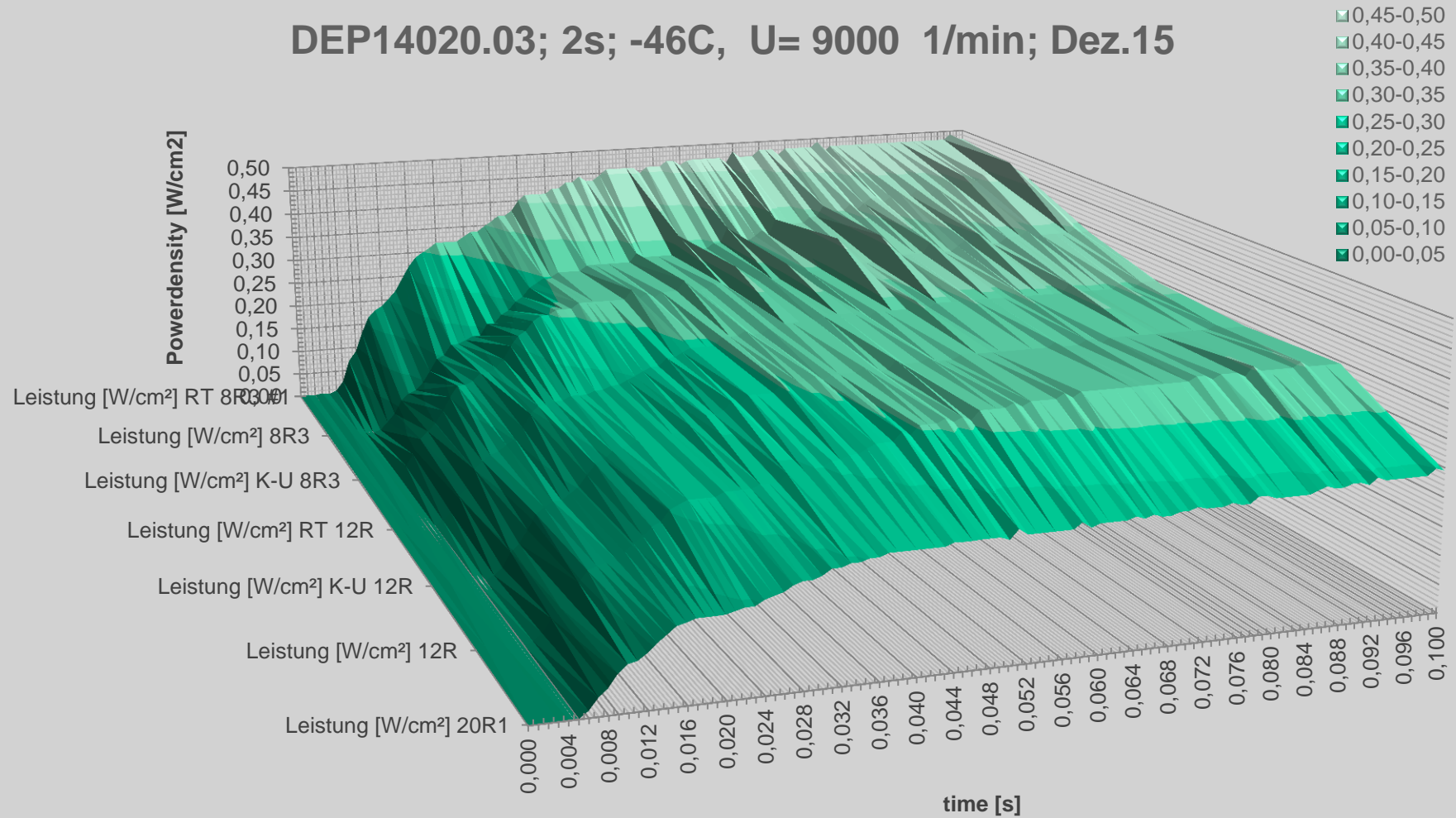

Recommended Load Characteristics

◆ Load Profile

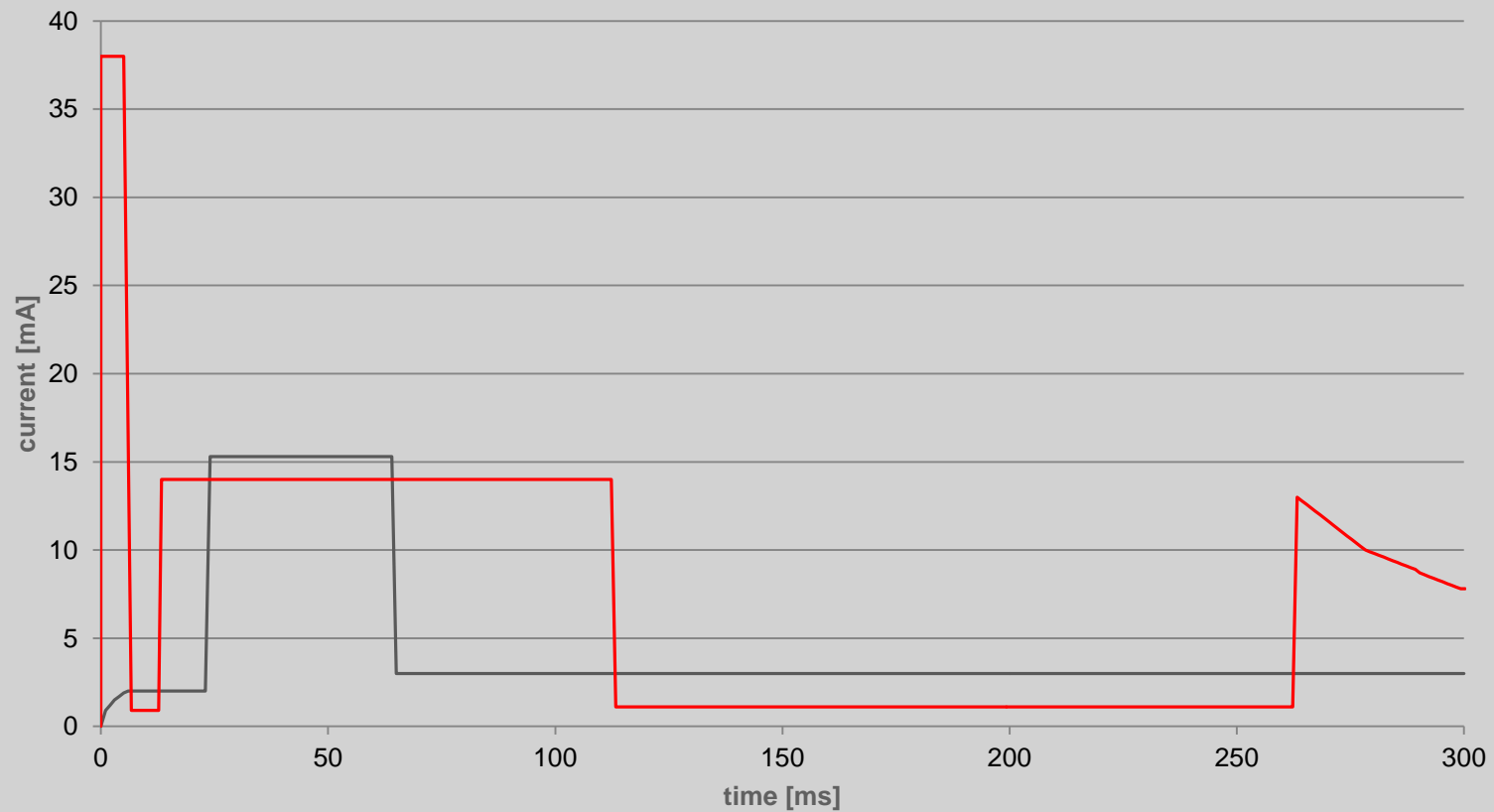

Conclusion

- ◆ Lithium Reserve Batteries provide very short Activation Time

- ▶ under high forces
 - Acceleration
 - Spin
- ▶ if properly designed
- ▶ under proper load management



Conclusion

- ◆ Lithium Reserve Batteries provide very short Activation Time
 - under high forces
 - Acceleration
 - Spin
 - if properly designed
 - under proper load management

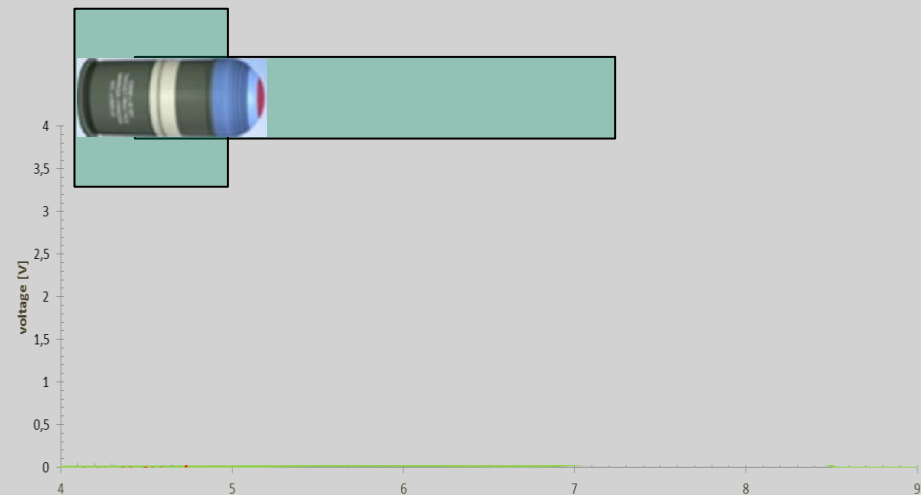

Lithium Reserve Batteries are able to provide “In-Barrel” Power!

Thank you for your attention!

Questions?

Diehl & Eagle Picher Contact

◆ How to Contact us

- Presenter Harald Wich
- Mail Diehl & Eagle Picher GmbH
Fischbachstrasse 20
90552 Roethenbach a d Pegnitz
Germany
- Phone +49-911-957-2100
- Fax +49-911-957-2485
- Email harald.wich@diehl-eagle-picher.com
- Web www.battery.de